

LT10SR-4700 Intelligent Level Transmitter

Features

- 4mA~20mA DC 2-wire current output;
- Digital temperature compensation and linearity correction;
- RS485 communication interface(Custom protocol) or HART®communication protocol(optional);
- Netting application;
- Full stainless steel construction, compact size, light weight;
- Special requirement available;
- RoHS Certificate;
- Intrinsic safe ex-proof version conforming to GB3836.4 Exia II BT6 Ga Regulation; Ex-proof Certificate is issued;
- Marine type products accord with CCS classification of sea-going steel ships of the rules "(2015) the requirements, has obtained the type approval.



Introduction

LT10SR-4700 level transmitter is the full stainless steel construction and full-sealed submersible intelligent level transmitter with high accuracy. It uses highly reliable and stable pressure sensor, intelligent processing circuit, precise digital temperature compensation and linearity correction technics for production. The water-proof cable connects with housing sealed, with vented tube putting in, the transmitter could be used in the water or liquid in a long time. Integrated construction and standard output signal could provide easy operation and good automatic control. With 2-wire working, compact size, light weight and easy installation and operation, it is widely used for industry field instead of normal 2-wire 4~20mADC analog output transmitter.

Specifications

Basic range (mH ₂ O)	3.5	7	10	20	35	70	100	200
Overpressure (mH ₂ O)	5	10	15	30	50	100	150	300
Note: The min.shrunked available range is 1/5 of basic range; For the other pressure range between min.range and max.range, but not indicated on the above table, we enlarge the above basic pressure range to produce (overpressure unavailable);								

Total accuracy ①③	±0.075%FS (min.)	±0.1%FS (typ.)	±0.25%FS (max.)
Power supply	10V~28VDC (RS485) , 12V~30VDC (HART®)		
	10V~12VDC (The Ann model, the security gate power supply)		
Output	4mA~20mADC		
	·RS485 communication interface(Custom protocol) or HART®communication protocol		
Compensation temp. ②	-10℃~70℃		
Operation temp.	-10℃~70℃, -20℃~60℃(Intrinsic safe)		
Storage temp.	-20℃~85℃		
Stability	±0.2%FS/year		

Load	4mA~20mADC output, (U-12V) /0.02A (Ω)
	RS485 bus line could connect with 99 transmitter
Insulation	100MΩ/50V
Shock	20g, 20Hz~5000Hz
Impact	20g, 11ms
Protection	IP68(Transmitter part);IP65(Junction box part)
Media compatibility	Diaphragm: stainless steel 316L
	Housing: stainless steel 1Cr18Ni9Ti
	O-ring: Viton
Weight	~250g

- ① Total accuracy: including non-linearity, hysteresis, repeatability and thermal error;
- ② For special temperature requirement, please contact with our company;
- ③ For pressure range 3.5mH₂O ad 7mH₂O, after shrinking, the total accuracy is ± 0.5%FS.

Outline Construction

(Unit: mm)

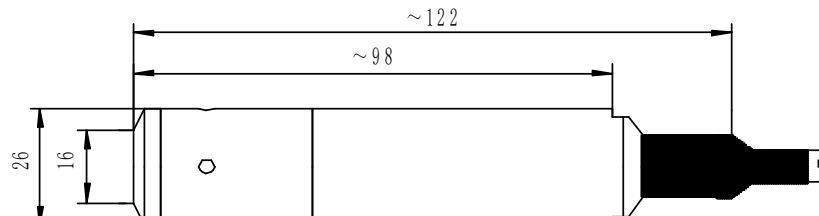

Electric Connection

Transmitter connecting the outside by cable or connection box;

Wire color	Terminal	Connection
Black	2	+V
Red	1	OUT/GND
Yellow(Green)	3	RS485A
White	4	RS485B
Blue	-	⊥

Note: conventional products are not grounded, explosion-proof products must be grounded

a) Electric connection for transmitter with 2-wire 4~20mADC output:

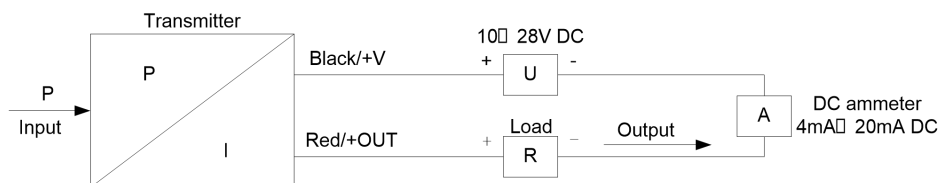

b) Electric connection for transmitter with RS485 interface:

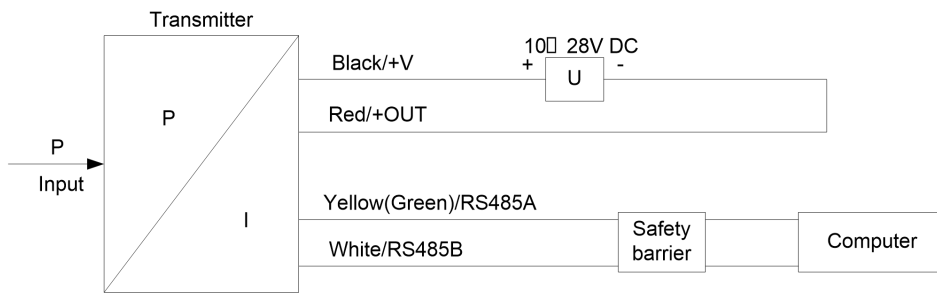

c) Wiring for HART® transmitter connecting with hand-communicator:

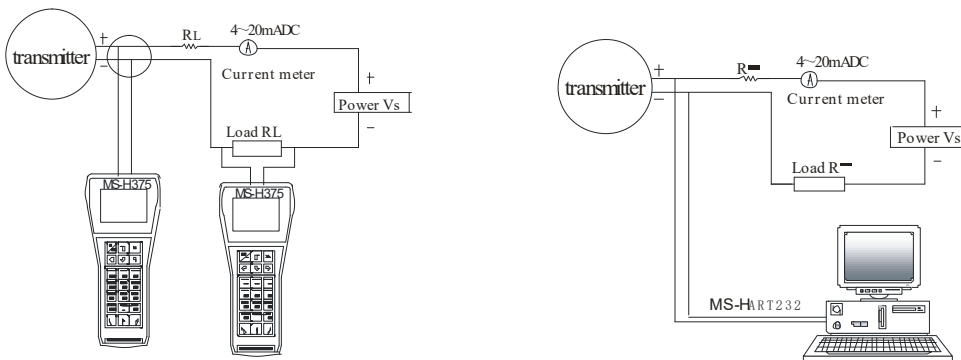

d) This Ann explosion-proof type electrical connection methods are shown below:

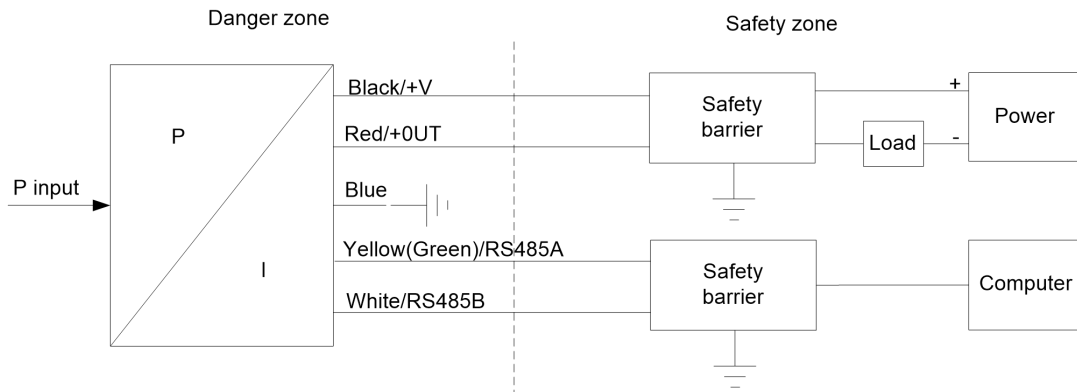

ExialIBT6 Ga

Transmitter Ex-proof parameter:

Ui: 12.4VDC li: 140mADC

Li: 0mH Ci: 1.049µF Pi: 0.43W

ExialIC

Safe barrier's ex-proof parameter:

Uo: 12.4VDC Io: 140mADC Po: 0.43W

Assistant Software

a) Transmitter Software (RS485 Interface type)

MS Setonline Software

Through RS232/485 conversation module, the user could read inner basic information for RS485 interface transmitter (including level range, compensated temp.range, version code, etc.) and display actual level, set new zero, analog output and device

Note: Software “MS Setonline” could be downloaded from our website www.microsensor.cn

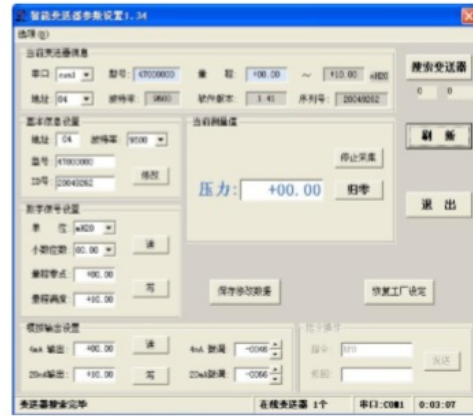

b) Transmitter Software (HART® protocol)

MS-C100ASoftwareThrough MS-HART 357 conversion module, the user could calibrate and adjust HART ® transmitter.



Application Example

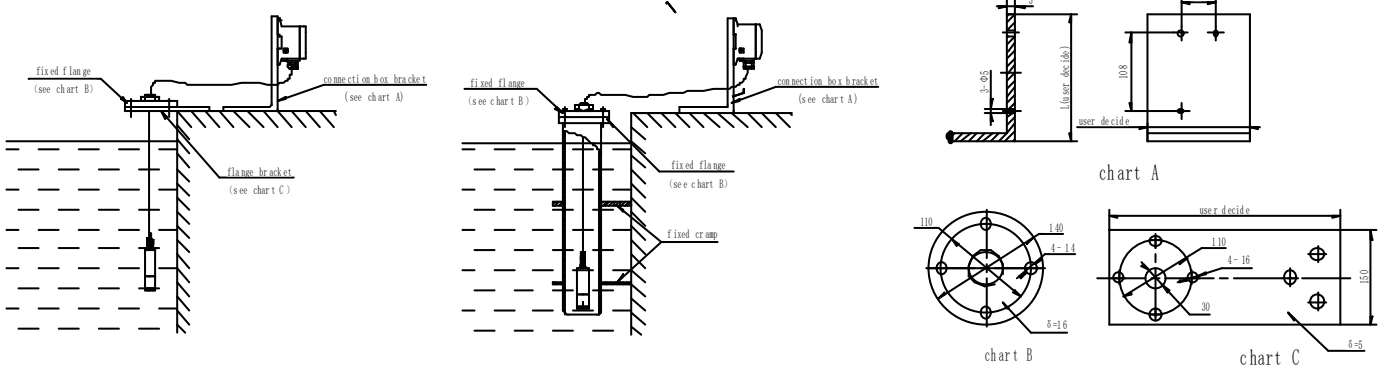

Order Guide

LT10SR-4700	Intelligent Level Transmitter				
	Range	Pressure range : 0m~3.5m...200mH2O			
	[0m~XmH2O]L	X=actual pressure range, L=cable length , suggested L-X= (1~2) m			
		Code	Output signal		
		E	4mA~20mADC		
		R ₄	RS485 communication interface, Custom protocol		
		R ₈	RS485 interface, MODBUS communication protocol		
		H	HART® communication protocol (No explosion proof)		
			Code		
			Construction material		
			Diaphragm Interface Housing		
		22	SS 316L SS SS		
		24	SS 316L SS 316L SS 316L		
			Code		
			Others		
		C ₁	M20×1.5 male, face type seal		
		C ₅	M20×1.5 male, waterline seal		
		Yb	Aluminum connection box without display		
		Yc	MS200 water-proof connection box(default)		
		Yd	PD140 lightning-proof protection device		
		Ye	connection box(with display or without		
		F ₁	Fixed flange		
		i	Intrinsic safe version Exia II BT6 Ga		
		T	Ship-use		
LT10SR-4700	[0m~10mH2O]12	ER ₄	22	Yc	the whole spec

Notes

1. If the user has no special requirement for cable, we provide default PVC cable;
2. If the user has special requirement, please feel free to contact our company.